

# Gain energy insight and control with PowerLogic™

## PowerLogic PM800

power and energy meters

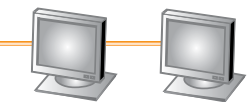

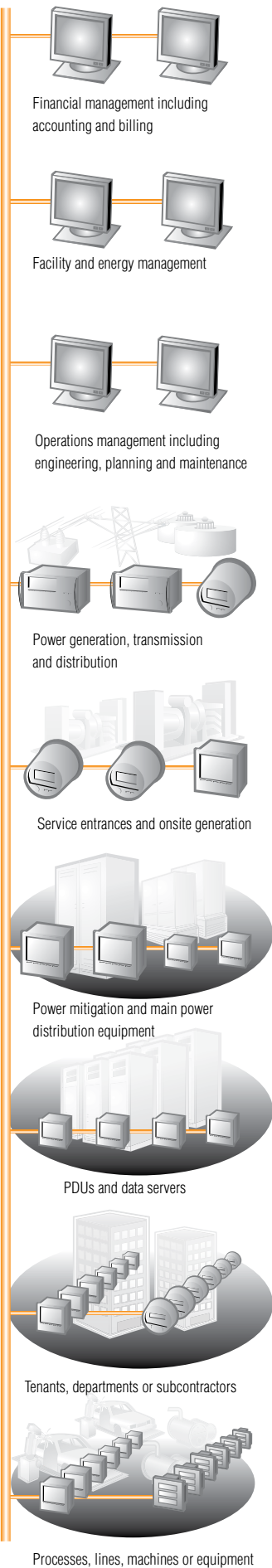

Financial management including accounting and billing

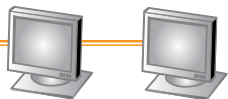

Facility and energy management



Operations management including engineering, planning and maintenance

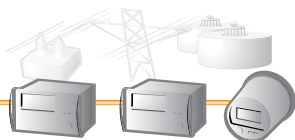

Power generation, transmission and distribution



Service entrances and onsite generation



Power mitigation and main power distribution equipment

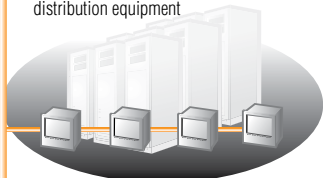

PDUs and data servers

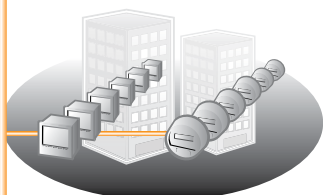

Tenants, departments or subcontractors

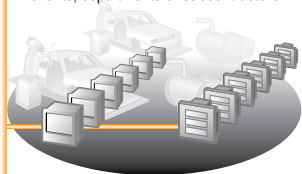

Processes, lines, machines or equipment

## Features

### Cost-effective, modular design

Standard features include a range of 3-phase power and energy measurements, total harmonic distortion (THD) metering, one RS-485 Modbus communication port, one digital input, one KY-type digital output, and alarming on critical conditions. A choice of four models offers incremental levels of custom logging and power quality analysis capabilities, while expansion modules offer additional logging, I/O and *Transparent Ready* Ethernet port. Downloadable firmware helps keeps meter capabilities updated.

### Easy installation

Mounts into panel cutouts using two clips with no tools required. Direct connect to circuits up to 600 VAC, eliminating the need for voltage (potential) transformers.

### High-visibility display

Optional integrated or remote LCD offers multi-phase measurements, summary screens, bar charts, intuitive navigation and selectable languages.

### High accuracy measurements

IEC 62053-22 class 0.5S and ANSI C12.20 0.5S energy accuracy for sub-billing and cost allocation.

### Power quality analysis

A choice of THD metering, individual current and voltage harmonics readings, waveform capture, EN50160 power quality compliance evaluation, and voltage and current disturbance (sag/swell) detection.

### Extensive data logging, trending and forecasting

Non-volatile on-board logging of min/max values, energy and demand, maintenance data, alarms, and any measured parameters. Trending and short-term forecasting of energy and demand.

### Custom alarming with time stamping

Trigger alarms on over 50 definable power or I/O conditions. Use boolean logic to combine up to four alarms.

### Expandable I/O

A wide choice of standard or optional digital and analog inputs and outputs for pulse counting, demand metering for other *WAGES* utilities (pulse inputs from water, air, gas electricity or steam meters), equipment status/position monitoring, demand synchronization, triggering conditional energy metering, equipment control or interfacing.

### Multi-port serial and Ethernet communications

Up to three simultaneous Modbus communication ports. Use the RS-485 port on the base meter unit or the optional Ethernet port that offers e-mail on alarm, web server and an Ethernet-to-serial RS485 gateway. The remote display adaptor option offers an additional RS-485/RS-232 port.



Panel-mount meter with integrated display.



DIN-rail mounted meter with remote display option, including adaptor, cable and display.



## Compact power, energy and power quality meters

The Schneider Electric PowerLogic PM800 series power meters combine accurate, 3-phase energy and power measurement with data logging, power quality analysis, alarm and I/O capabilities not typically available in a compact meter. The meters are ideally suited to local and remote monitoring of low or high voltage electrical installations in industrial facilities, commercial buildings, utility networks or critical power environments. Facility and operations personnel will benefit in reducing energy-related costs while avoiding power quality conditions that can reduce equipment life and productivity.

PowerLogic PM800 series meters are easy to install and use, offering integrated or remote high-visibility displays. A choice of four models and a range of expansion modules help match features to the application and support field-upgrading of meters as required. Serial and Ethernet communication options enable the meters to be used within a PowerLogic power and energy management system or with third-party automation systems.

### Typical applications

#### For infrastructure, industrials and buildings

- Energy savings
  - Measure efficiency, reveal opportunities and verify savings
  - Sub-bill tenants for energy costs
  - Allocate energy costs to departments or processes
  - Reduce peak demand surcharges
  - Reduce power factor penalties
  - Leverage existing infrastructure capacity and avoid over-building
  - Support proactive maintenance to prolong asset life
- Energy availability and reliability
  - Validate that power quality complies with the energy contract
  - Verify the reliable operation of equipment
  - Improve response to power quality-related problems

#### For electric utilities

- Energy availability and reliability
  - Improve T&D network reliability
  - Enhance substation automation to reduce field service time
  - Maximise the use of existing infrastructure
- Power quality
  - Verify compliance with new power quality standards
  - Analyse and isolate the source of power quality problems

# Installation

## Mounting Options

A meter with integrated display, or a remote display module, can be panel mounted through a square cutout or retrofit through an existing round meter hole using two clips with no tools required. A small panel footprint and shallow depth make the meters suitable for low voltage switchboards, shallow cable compartments or on standalone machines. The meter unit (without display) is DIN rail compatible.

Meters with the optional integrated display can be door panel mounted when voltage connections are within the local regulation limits. When voltage exceeds regulation limits, the meter unit can be mounted inside the electrical cabinet with an optional remote display connecting via a display adaptor and cable. The display adaptor includes a configurable 2- or 4-wire RS-485/RS-232 port. A single remote display can be transferred between any meter units equipped with display adaptors.

## Circuit and control power connections

Compatible with low and high voltage 4-wire wye and 3-wire delta systems. Direct connect inputs up to 600 V ac line-to-line or use voltage (potential) transformers for higher voltage systems. All models offer a universal AC or DC power supply.

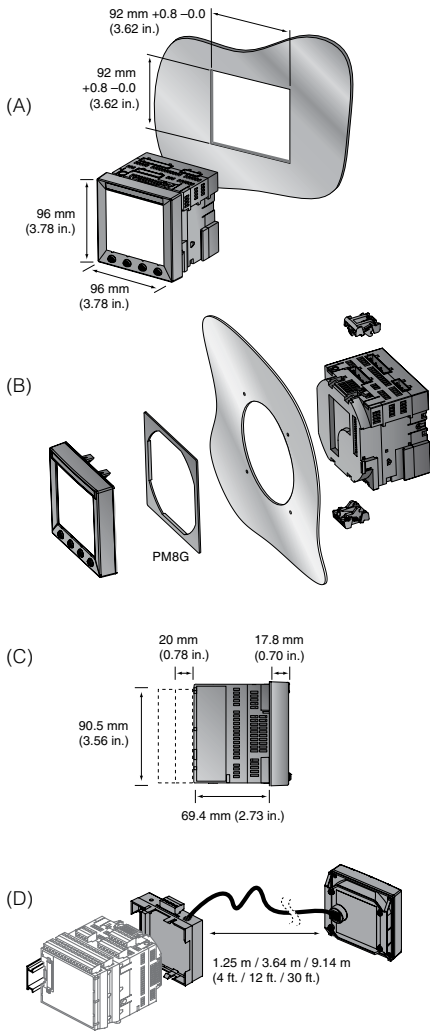

- A. Meter with integrated display panel mounted into square cutout.
- B. Meter with integrated display retrofit into existing 4" round meter cutout.
- C. Meter unit side view showing mounting depth with and without option modules.
- D. DIN rail mounted meter unit with optional remote display package, including display adaptor module, display cable and display module. Three cable length options are available.

Input(s)	Specifications
<b>Voltage inputs</b>	
Nominal full scale (Un)	347 direct V ac line-to-neutral, 600 V ac direct line-to-line, up to 3.2 MV with external VT/PT
Metering over-range	1.5 Un (50%)
Input impedance	5 MΩ
Frequency range	45 to 67 Hz, 350 to 450 Hz
<b>Current inputs</b>	
Nominal current	1 A or 5 A ac
Metering range	5 mA to 10 A ac
Withstand	15 A continuous, 50 A for 10 s per hour, 500 A for 1 s per hour
Load/burden	< 0.15 VA
Impedance	< 0.1 Ω
<b>Control power</b>	
Operating range	115 to 415 V ac ±10% at 45 to 67 Hz or 350 to 450 Hz 125 to 250 V dc ±20%
Load/burden	15 VA (ac) or 10 W (dc) with all options
Ride through	45 ms at 120 V ac or 125 V dc

## Front panel display

The unique, anti-glare backlit white LCD can be easily read in extreme lighting conditions or viewing angles. An intuitive navigation with self-guided menus make the meter easy to use. Multilingual operation can be user-configured for English, French, Spanish, German, Russian, Turkish, Portuguese\*.

The large 6-line display offers summary screens that simultaneously presents up to 4 concurrent values, including power and energy values, I/O conditions or alarm status. For example, all three voltage or current phases plus neutral can be quickly reviewed at one time. Bar chart displays graphically represent system loading and I/O conditions. Historical and active alarms are displayed with time stamping.



Front panel display showing function selection buttons and 3-phase voltage, current and power summary display.

\* Contact your Schneider Electric representative for availability of additional languages

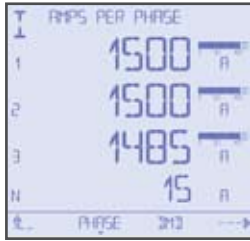

3-phase and neutral current display



Energy in, out, total display



Peak power demand date/time display



Digital inputs display



Current total harmonic distortion display



Alarm display showing active alarm display

## Power and energy measurements

Metering is performed by zero-blind sampling all inputs at 128 samples/cycle with a data update rate of 1 second. The meter offers a range of high-accuracy instantaneous RMS, power, demand and energy measurements suitable for real-time monitoring, energy management and sub-billing purposes.

Measurement	Accuracy
Current: per phase, neutral, min/max	± (0.075% reading + 0.025% full scale) <sup>3</sup>
Current demand: present, peak, predicted <sup>1</sup>	
Voltage (line-line, line-neutral): per phase, min/max, unbalance	± (0.075% reading + 0.025% full scale) <sup>4</sup>
Power: real (kW), reactive (kVAr), apparent (kVA), per-phase, total	± (0.15% reading + 0.025% full scale) <sup>5</sup>
Power demand: present, peak, predicted <sup>1</sup>	
Energy: real (kWh), reactive (kVArh), apparent (kVAh), in/out <sup>2</sup>	IEC 62053-22 0.5S (real), IEC 62053-23 Class 2 (reactive), ANSI C12.20 0.5S
Power factor: true and displacement, per phase, total, min/max	± 0.002 to 0.500 leading and ± 0.002 to 0.500 lagging
Frequency: present, min/max	±0.01 Hz at 45 to 67 Hz, ±0.01 Hz at 350 to 450 Hz

- 1 Selectable block, sliding, or thermal demand calculation mode with internal or external (via digital input) demand synchronization.
- 2 Configurable accumulation mode, triggerable from digital input.
- 3 Full scale = 10 A. Add 0.006% to upper limit error for operating temperatures under 25 °C
- 4 Full scale = 600 V. Add 0.001% to upper limit error for operating temperatures over 50 °C
- 5 Full scale = 120 V x 10 A. Add 0.006% to upper limit error for operating temperatures under 25 °C

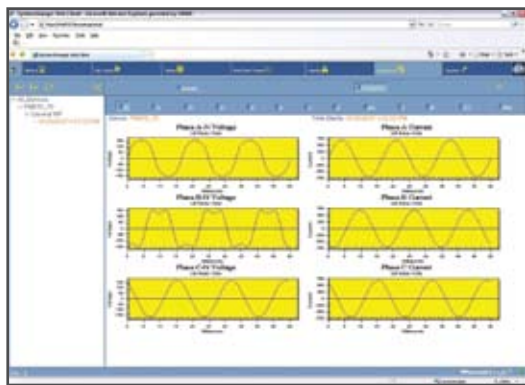

Captured voltage and current waveforms viewed using PowerLogic System Manager.

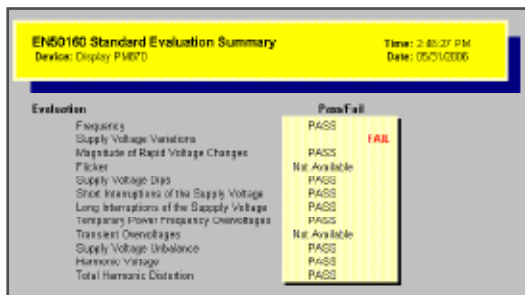

EN501650 evaluation summary viewed using PowerLogic System Manager.

## Power quality analysis

A choice of models offers an incremental range of measurement and event capture features for troubleshooting and preventing power quality related problems.

- **Basic THD** (all models): on voltage and current, per phase, min/max, custom alarming (see Alarm section)
- **Individual harmonic magnitudes and angles** (all models, PM810 requires PM810LOG option): on voltage and current, up to the 31st harmonic for the PM810 and PM820, up to the 63rd for PM850 and PM870.
- **Waveform capture** (PM850 and PM870): triggered manually or by alarm, 3-cycle, 128 samples/cycle on 6 user configurable channels, manual or alarm-triggered initiation.
- **Configurable waveform capture** (PM870): flexible resolution permits you to adapt the waveform captures according to the type of event/disturbance on selected channels, from 185 cycles on 1 channel at 16 samples per cycle up to 3 cycles on 6 channels at 128 samples per cycle
- **EN50160 standard compliance evaluation** (PM850 and PM870): pass/fail indication on power frequency, supply voltage magnitude, supply voltage dips, short and long interruptions, temporary overvoltages, voltage unbalance and harmonic voltage.
- **Disturbance detection** (PM870): sag/swell on any current and voltage channel, alarm on disturbances.

Use PowerLogic ION Enterprise or PowerLogic System Manager software to upload and graphically plot waveforms to help analyze conditions and isolate problems.

Time of Occur	Device	Function	State
2/10/2006 11:11	PM870	Sag Vab	Renormalized
2/10/2006 11:12	PM870	Sag Vab	Renormalized
2/10/2006 11:13	PM870	Sag Vab	Renormalized
2/10/2006 12:12	PM870	Sag Vab	Voltage/Current Sag Pickup
2/10/2006 11:11	PM870	Sag Vab	Voltage/Current Sag Pickup
2/10/2006 10:11	PM870	Sag Vab	Voltage/Current Sag Pickup

Meter alarm log viewed using PowerLogic System Manager software.

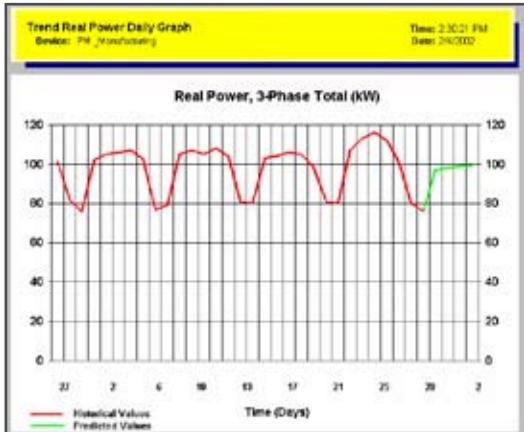

Meter trend log with forecasting, viewed using PowerLogic System Manager software.

## Data and event logging

On-board nonvolatile memory retains critical information and eliminates data gaps that can occur due to network outages or computer server downtime.

Minimum/maximum log: for all instantaneous readings, logs worst phase since last reset with date and time stamp. See measurements table for parameters logged.

Maintenance log (all models): records date and time of energy, I/O and demand resets, firmware downloads, power failures and option module changes.

Alarm log: records all user-defined alarm conditions with date/time stamping to 1 second resolution.

Billing log and energy per interval (PM810 requires PM810LOG option): logs kWh and kVARh in and total, kVAh and PF total, kW and kVar demand.

Logging is user-configurable from five minutes to one day. Energy-per-interval log tracks usage and cost up to three user-definable shifts per day.

Customizable data logs (PM810 requires PM810LOG option): One on PM810 and PM820, three on PM850 and PM870. Each log can record up to 96 user-definable parameters.

Trending and forecasting (PM850 and PM870): trending for energy and demand average, minimum and maximum values by four trend curves. Min/max and average data available for each quantity at intervals of minutes, hours, days and months. Forecasting feature “looks into the future” by automatically forecasting average, minimum and maximum for the next four hours and next four days. Statistical summaries available for hours and weeks.

Logging capacity is 80 kB for PM810 (with PM810LOG option) and PM820, and 800 kB for PM850 and PM870. All models provide a battery-backed internal clock (PM810 requires PM810LOG option). Default logging is set at the factory, logging starts as soon as meter is powered up.

## Digital and analog inputs and outputs

All models provide a single digital status/counter input and digital (KY type) output. Optional field-installable expansion modules add more digital and analog I/O. Meters accommodate up to two expansion modules (including logging or communication modules).

Digital output relays can respond to internal alarms, external digital input status changes, or commands over communications. Digital inputs can trigger alarms and logging, synchronize to demand pulses or control conditional energy accumulation. All models offer five channels for WAGES metering through the digital input pulse counting and consumption/demand calculation capabilities of the meter. Pulses from multiple inputs can be summed through a single channel



Attachment of logging, I/O, or Ethernet expansion modules to meter unit.



Bottom view of PM8ECC Ethernet communications module and main meter unit, showing Ethernet and RS-485 communication port connectors and configuration switches.

Type	Input / output	Specifications
Standard (meter unit)	1 digital KY output	6 to 220 V ac $\pm 10\%$ or 3 to 250 V dc $\pm 10\%$ , 100 mA maximum at 25 °C, 1350 V rms isolation
	1 digital input	20 to 150 V ac/dc $\pm 10\%$ , < 5 mA maximum burden
PM8M22 option	2 digital relay outputs <sup>1</sup>	6 to 240 V ac or 6 to 30 V dc, 2 A rms, 5 A maximum for 10 seconds/hour
	2 digital inputs	19 to 30 V dc, 5 mA max. at 24 V dc
PM8M26 option	2 digital relay outputs <sup>1</sup>	6 to 240 V ac or 6 to 30 V dc, 2 A rms, 5 A maximum for 10 seconds/hour
	6 digital inputs	20 to 150 V ac/dc, 2 mA max., 24 V internal supply: 20 to 34 V dc, 10 mA maximum (feeds 6 inputs)
PM8M2222 option <sup>2</sup>	2 digital relay outputs <sup>1</sup>	6 to 240 V ac or 6 to 30 V dc, 2 A rms, 5 A maximum for 10 seconds/hour
	2 digital inputs	20 to 150 V ac/dc, 2 mA maximum
	2 analog outputs	4 to 20 mA dc into 600 $\Omega$ maximum
	2 analog inputs	Adjustable from 0 to 5 V dc or 4-20 mA dc

<sup>1</sup> Endurance: 15 million operations, 25000 commutations at 2 A / 250 V ac

<sup>2</sup> When using two PM8M2222 modules the temperature should not exceed 25 °C.

Alarm Summary Readings			
Device: PM870_5		Time: 12:15:17 PM Date: 06/05/2016	
Over Current	Count	Average Magnitude	Average Duration
Today	2	10E21	19
Yesterday	N/A	N/A	N/A
This Week	2	10E21	19
Last Week	N/A	N/A	N/A
This Month	2	10E21	19
Last Month	N/A	N/A	N/A
This Year	2	10E21	19
Last Year	N/A	N/A	N/A
Trend (30 Days)	N/A	N/A	N/A
Trend (52 Weeks)	N/A	N/A	N/A

Meter alarm summary report viewed using PowerLogic System Manager software.

Example web page provided by the PM8ECC option of a PowerLogic PM800 series meter showing instantaneous power readings.



Example screen from PowerLogic ION Enterprise software showing electrical system diagram with multiple real-time metering points.

## General specifications

Description	Specification
Weight	No options, no display: 0.5 kg (1.1 lb.) With integrated display 0.6 kg (1.3 lb.)
Safety	Europe: CE as per IEC 61010-1 protected throughout by double insulation. US and Canada: UL508, cUL508
Operating temp.	Meter: -25 °C to +70 °C. Display: -10 °C to +50 °C. Derating may apply with remote display or multiple option modules, see installation manual.
Storage temp.	-40 °C to +85 °C
Relative humidity	5 to 95% at 40 °C (non-condensing)
Altitude	3000 m maximum.
Pollution degree	2
Installation category	III, for distribution systems up to 347 V ac line-to-neutral / 600 V ac line-to-line
Dielectric withstand	As per EN 61010, UL508
IP degree of protection	As per IEC 60529: IP52 front display, IP30 meter body
Immunity	ESD: IEC 61000-4-2 Level 3, Radiated: IEC 61000-4-3 Level 3, Fast transients: IEC 61000-4-4 Level 3, Impulse waves: IEC 61000-4-5 Level 3 Conducted: IEC 61000-4-6 Level 3, Magnetic field: IEC 61000-4-8 Level 3, Voltage dips: IEC 61000-4-11
Emissions	Conducted and radiated: CE industrial environment / FCC part 15 class A EN 55011, Harmonics: IEC 61000-3-2, Flicker: IEC 61000-3-3

## Alarm and control functions

Over 50 definable alarm conditions with 1 second response time can be used to log critical events or to perform control functions. Trigger on over or under conditions on any measured parameters, phase unbalance, digital input changes and more.

Multiple alarms can be defined, with each alarm individually configured with pickup setpoint, dropout setpoint and delay. Each alarm can be assigned one of four priority classes. Assign multiple alarms to a single quantity to create alarm levels. Assign different actions based on the severity level of the alarm. Use alarms to trigger waveform recording, data logging or to control digital outputs.

Boolean alarm logic (PM850 and PM870 only) increases flexibility by allowing the combination of up to four other alarms using NAND, AND, OR, NOR and XOR functions.

## Communications

Multiple simultaneously operating communication ports allow the meters to be used as part of a power and energy management system and interface with other automation systems. Captured waveforms, alarms, billing data, and more can be uploaded to software for viewing and analysis. Option modules offer a choice of communications standards.

- **Standard RS-485 port (on meter unit):** 2-wire connection, up to 38.4 kbaud, Modbus (ASCII and RTU) or JBUS protocol.
- **PM8RDA display adaptor module:** offers a second RS-485/232 port, 2- or 4-wire, Modbus (ASCII and RTU). Port is disabled if a PM8ECC module is installed.
- **PM8ECC Ethernet module:** 10/100 Base-T UTP port supporting ModbusTCP/IP communications. Fully compliant with Transparent Ready - Level 1 systems, including full-function embedded web server providing standard web browser access to meter data, and the ability to email on an alarm from the host meter. RS-485/232 port, 2- or 4-wire, Modbus (ASCII and RTU) master port providing Ethernet-to-serial line gateway functionality.

## Software integration

Integrate within PowerLogic facility-level or enterprise-wide power and energy management systems. Real-time data and data logs stored onboard can be automatically retrieved for analysis at the system level. Compatible with PowerLogic ION Enterprise, PowerLogic System Manager, PowerLogic PowerView and PowerLogic Tenant Metering software. Modbus compatibility and register-based logged data supports integration and data access by building automation, SCADA and other third-party systems.

## Special features

**Hour counter:** load running time in days, hours and minutes.  
**Downloadable firmware:** update your meters with the latest features by simply downloading them from [www.powerlogic.com](http://www.powerlogic.com).

Features and options	PM810	PM820	PM850	PM870
<b>Installation</b>				
Fast installation, panel or DIN mount, integrated or remote display	■	■	■	■
<b>Display</b>				
Backlit LCD, multilingual, bar graphs	■	■	■	■
<b>Power and energy metering</b>				
3-phase voltage, current, power, demand, energy, frequency, power factor	■	■	■	■
<b>Power quality analysis</b>				
THD	■	■	■	■
Harmonics: individual, up to	31	31	63	63
Waveform recording			standard	enhanced
EN50160 compliance evaluation			■	■
Disturbance (dip/swell) monitoring				■
<b>Data and event logging</b>				
Memory capacity	80 kB <sup>1</sup>	80 kB	800 kB	800 kB
Min/max log	■	■	■	■
Maintenance, alarm and event logs	■	■	■	■
Billing (energy, demand) log	■	■	■	■
Energy per interval	■	■	■	■
Customizable data logs	1 optional	1	3	3
Trending and forecasting			■	■
Timestamp resolution in seconds	1	1	1	1
<b>Digital and analog inputs/outputs</b>				
Digital inputs (standard / optional) <sup>2</sup>	1/12	1/12	1/12	1/12
Digital outputs (standard / optional) <sup>3</sup>	1/4	1/4	1/4	1/4
Analog inputs (standard / optional)	0/4	0/4	0/4	0/4
Analog outputs (standard / optional)	0/4	0/4	0/4	0/4
<b>Alarms and control</b>				
Setpoint response time, seconds	1	1	1	1
Single & multi-condition alarms	■	■	■	■
Boolean alarm logic			■	■
<b>Communications</b>				
Serial ports with Modbus protocol	<input type="checkbox"/> Standard meter offers one RS-485 port. <input type="checkbox"/> Optional PM8RDA remote display module offers one RS-485/RS-232 port. <input type="checkbox"/> Optional PM8ECC Ethernet module offers one RS-485 port.			
Ethernet port with Modbus TCP protocol Embedded web server Ethernet to RS-485 gateway	Optional PM8ECC module			

1 Requires PM810LOG option.

2 On-board and optional digital inputs can be used for on/off status monitoring or for pulse counting.

3 On-board digital output is KY type, optional digital outputs are relay type.

Schneider Electric  
 35 Rue Joseph Monier  
 CS 30323  
 92506 Rueil Malmaison Cedex  
 Tel : +33 (0)1 41 29 70 00  
 Fax : +33 (0)1 41 29 71 00  
 www.powerlogic.com  
 www.schneider-electric.com

As standards, specifications and designs develop from time to time, always ask for confirmation of the information given in this publication. PowerLogic, ION, ION Enterprise, MeterM@il and Modbus are either trademarks or registered trademarks of Schneider Electric.



Printed on recycled paper

Publishing : Schneider Electric  
 Production : Schneider Electric PMC  
 Printing : Imprimerie du Pont de Claix - made in France



"The 2007 award recognizes Schneider Electric for its technological advancements and wide product range in the field of power quality (PQ) and energy management solutions. In total, this is the fourth award that Schneider Electric and [recently acquired] Power Measurement have received from Frost & Sullivan in recognition of achievements in this arena."  
*Prithvi Raj, Frost & Sullivan research analyst*



Please contact your local sales representative for ordering information.

Visit [www.powerlogic.com](http://www.powerlogic.com) for more information on other PowerLogic products, applications and system solutions.