

# Gain energy insight and control with PowerLogic™

## PowerLogic ION6200

power and energy meter



# PowerLogic ION6200 power and energy meter

The Schneider Electric PowerLogic ION6200 meter offers outstanding quality, versatility, and functionality in a low-cost, ultra-compact unit. The meter is simple to use and offers a bright LED display for superior readability in poor lighting conditions.

Complete with four-quadrant power, demand, energy, power factor, and frequency measurements, this versatile unit is easy to wire and mount. It offers an excellent upgrade path that lets you start with a low-cost base model and add enhanced functionality as your power and energy needs evolve.

The PowerLogic ION6200 meter lets you upgrade functionality in the field. Rather than carry a large inventory of pre-configured meters, genset and electrical equipment manufacturers, panel shops, EMS manufacturers and energy service providers can each adapt meter functionality to specific applications, as required.

## Typical applications

For infrastructure, industrials and buildings

- Energy savings
  - Measure efficiency, reveal opportunities and verify savings
  - Sub-bill tenants for energy costs
  - Allocate energy costs to departments or processes
  - Reduce peak demand surcharges
  - Reduce power factor penalties
  - Leverage existing infrastructure capacity and avoid over-building
- Energy availability and reliability
  - Verify the reliable operation of equipment
  - Improve response to power quality-related problems

For electric utilities

- Energy availability and reliability
  - Enhance substation automation to reduce field service time



Integrated network comprising corporate intranet, Internet, serial, dialup or wireless connections

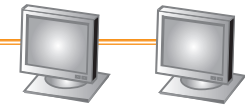

Financial management including accounting and billing

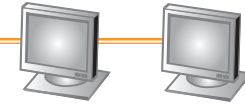

Facility and energy management

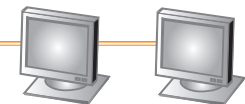

Operations management including engineering, planning and maintenance

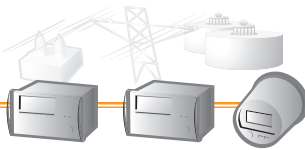

Power generation, transmission and distribution



Service entrances and onsite generation



Power mitigation and main power distribution equipment

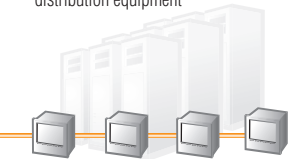

PDUs and data servers

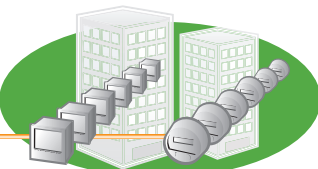

Tenants, departments or subcontractors

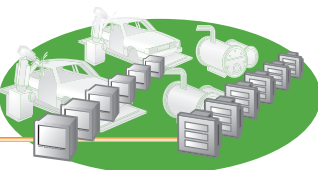

Processes, lines, machines or equipment

# Features

## Replace multiple analog meters

PowerLogic ION6200 meters are ideal replacements for analog meters. Use for stand-alone metering in custom panels, switchboards, switchgear, gensets, motor control centres, and UPS systems.

## Modularity

Simple retrofit, low initial investment that can meet future needs. Retrofittable upgrades add functionality as required.

## Ease of use

Fast setup via display or software.

## Measurements

- IEC 60687 class 0.5 accuracy
- ANSI C12.20 0.5 compliant
- 4 Quadrant energy & demand
- True RMS electrical parameters: per phase voltage, current, peak current demand, watts, vars, kWh, and more
- Neutral current, THD, frequency, power factor, and more
- Energy: bi-directional, absolute & net
- Demand: rolling block
- 64 samples per cycle
- Total harmonic distortion.

## Communications

RS-485 port, Modbus RTU for integration with energy management systems

## Management and monitoring systems

PowerLogic-compatible protocol for use with PowerLogic ION Enterprise or PowerLogic PowerView software.

## Pulse outputs

2 outputs for kWh, kvarh or kVAh pulsing.

## Front panel display

Large, bright, easily-read LED display. Intuitive navigation system with self-guided menus for easy setup on common configuration parameters. Displays all basic power parameters with password protection on setup parameters and for demand resets.

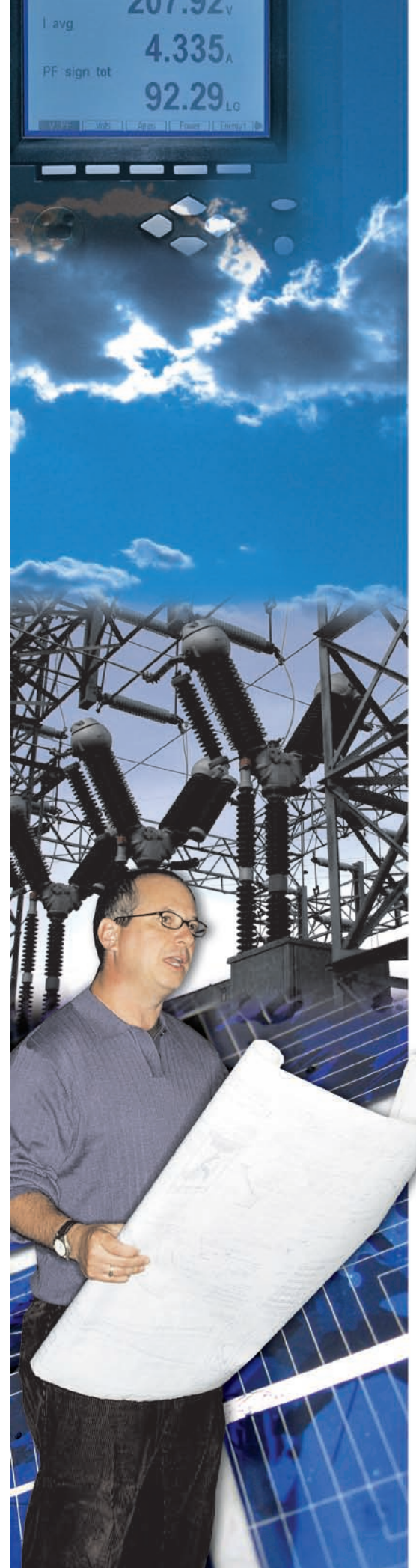

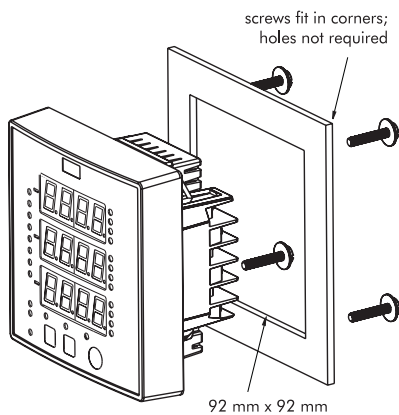
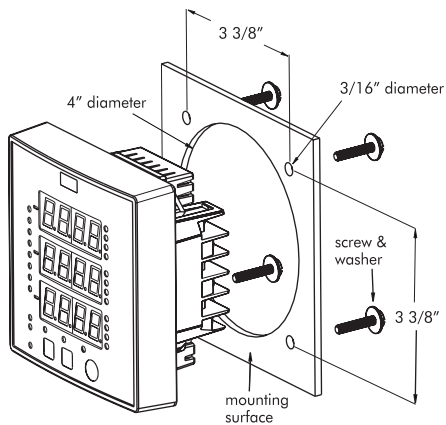

Panel mount into existing round or new square cutouts.

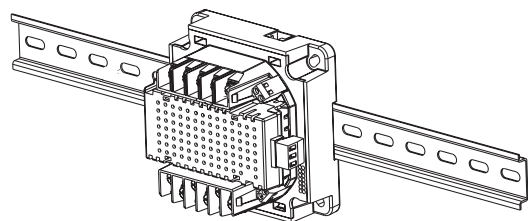

PowerLogic ION6200 TRAN model mounting.

## Installation

### Mounting options

Integrated models have a built-in display and fit in a DIN 96 and an ANSI 4" cutout. Transducer (TRAN) models have no display and can be fastened to a flat surface with a 4" ANSI bolt pattern or mounted to a DIN rail. A Remote Display Module (RMD) can be ordered for the TRAN model and mounted through an ANSI 4" and DIN 96 cutout. A 14ft. cable is standard with this option.

### Circuit and control power connections

The meter is compatible with low and high voltage 4-wire wye and 3-wire delta systems. PTs are required for all systems with voltage levels greater than 60 to 400 LN (103.5 – 690 LL) V ac RMS (three phase), 60 to 400 L-N V ac (single phase). The meter inputs can be used with PTs that have secondaries rated between 50 V ac and 347 V ac +25%. Use CTs that are compliant with the electrical safety code in your region.

## Options

### Remote modular display (RMD) option

The Remote Modular Display (RMD) is a product option for ION6200 TRAN meters. The RMD can be mounted in either a standard DIN or ANSI cutout. When the RMD unit is mounted flush to a panel, the front side meets type 4, 4x and 5 of NEMA standards 1-10-1979 and 5-25-1988.

### Megawatt option

The Megawatt option of the Powerlogic ION6200 displays all power and energy values in millions (e.g. megawatts) and volts in thousands (kilovolts), using a different front panel faceplate than the standard meter, with labels for kV, MW, MVA, Mvar, MWh, MVAh, and Mvarh.

### Power supply options

The meter is available with three power supply options: Standard ac / dc power supply (ac: 100 to 240 V ac, 50 to 60 Hz; dc: 110 to 300 V dc); Low Voltage dc power supply (20 to 60 V dc); and 480 V power supply (480 V ac, 60 Hz).

### Options card

While the basic meter has an options card that enables standard measurements (voltage and current), the meter is also available with an options card that extends meter capabilities, including RS-485 communications, two digital pulse outputs, and additional measurements (see Enhanced Measurement Packages 1 and 2 in the table on the last page of this publication).

### Revenue meter option

This option provides power measurements that are within industry-accepted limits for accuracy over a defined range of operating conditions, and provides adequate protection against unauthorized alteration of these measured quantities.



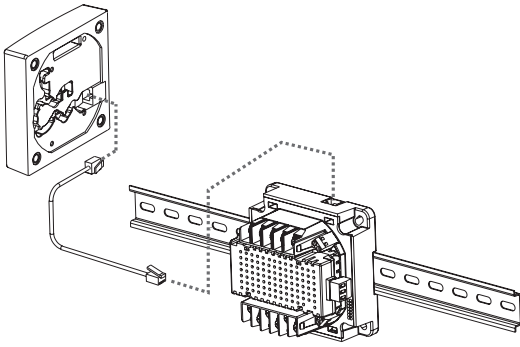

Remote modular display (RMD) option

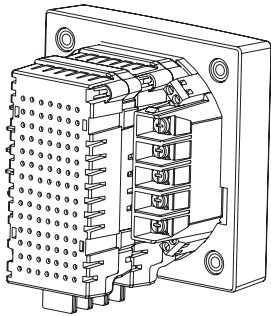

Retrofittable power supply options are available

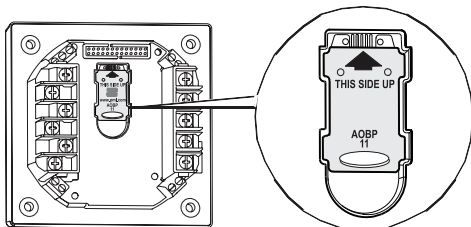

PowerLogic ION6200 Enhanced Measurement Package (EP) card option

## Specifications

### Accuracy

- Voltage : L-N 0.3% reading, L-L 0.5% reading
- Frequency : +/- 0.1 Hz
- Current :
  - $\geq 5\%$  of full scale : 0.3% reading
  - $< 5\%$  of full scale : 0.3% reading + 0.05% full scale
  - I4 derivation : 0.6% reading + 0.05% full scale
- Power factor : 1.0% reading
- Total harmonic distortion (THD) : +/-1.0%
- Power and energy measurements :
  - kW, kVA, kvar, kWh, kVAh, kvarh
  - Complies with IEC 60687 Class 0.5S and ANSI 12.20 Class 0.5 (0.5% reading)

### Environmental conditions

- Operating temp : -20° C to 70° C (-4° F to 158° F)
- Storage : -40° C to 85° C (-40° F to 185° F)
- Humidity : 5% to 95% non-condensing

### Installation and input ratings

- 64 samples per cycle true rms
- Autoranging voltage inputs allow direct connection to 400/690 V ac systems (the meter is calibrated for 60 to 400 V ac L-N connections)
- Supports Direct 4-wire Wye, 3-wire Wye, 3-wire Delta, Direct Delta and single phase configurations
- 3-phase voltage and current inputs
- Impedance : 2 M $\Omega$  per phase
- Burden: 0.05 VA (typical) @ 5 A rms
- 5 A nominal / 10 A full scale / 20% overrange full accuracy
- Current overload rating 120 A for 1 second
- Standard terminal strip covers

### Dimensions and shipping

- Base unit: 106.7 x 106.7 x 40.6 mm (4.2" x 4.2" x 1.6")
- Remote display: 106.7 x 106.7 x 22.9 mm (4.2" x 4.2" x 0.9")
- Shipping weight: 0.68 kg (1.5 lb)

### Software integration

Integrate within PowerLogic facility-level or enterprise-wide power and energy management systems. Compatible with PowerLogic ION Enterprise, PowerLogic PowerView and PowerLogic ION Setup software.

Standard & enhanced measurements		Standard	EP #1	EP #2
<b>Voltage L-N</b>	per phase	■	■	■
<b>Voltage L-L</b>	average	■	■	■
	per phase	■	■	■
<b>Frequency</b>			■	■
<b>Current</b>	average	■	■	■
	per phase	■	■	■
<b>I4</b>			■	■
<b>kW/MW</b>	total		■	■
	per phase			■
<b>kVAR/MVAR</b>	total			■
	per phase			■
<b>kVA/MVA</b>	total			■
	per phase			■
<b>kWh/MWh</b>	total		■	■
In/out (imp/exp)	per phase			■
<b>kVARh/MVARh</b>	total			■
In/out (imp/exp)	per phase			■
<b>kVAh/MVAh</b>	total			■
	per phase			■
<b>kW/MW</b>	demand			■
	peak		■	■
<b>kVAR/MVAR</b>	demand			■
	peak			■
<b>kVA/MVA</b>	demand			■
	peak			■
<b>Current demand</b>	average		■	■
	per phase		■	■
<b>Current peak demand</b>	average		■	■
	per phase		■	■
<b>Power factor</b>	total		■	■
	per phase			■
<b>Voltage THD</b>	per phase			■
<b>Current THD</b>	per phase			■

2007

FROST &amp; SULLIVAN

North American Frost & Sullivan  
Award for Product Innovation

"The 2007 award recognizes Schneider Electric for its technological advancements and wide product range in the field of power quality (PQ) and energy management solutions. In total, this is the fourth award that Schneider Electric and [recently acquired] Power Measurement have received from Frost & Sullivan in recognition of achievements in this arena."  
Prithvi Raj, Frost & Sullivan research analyst

DIGITAL  
POWER  
METER  
20SJ

Please contact your local sales representative for ordering information.

Visit [www.powerlogic.com](http://www.powerlogic.com) for more information on other PowerLogic products, applications and system solutions.

Schneider Electric  
35 Rue Joseph Monier  
CS 30323  
92506 Rueil Malmaison Cedex  
Tel : +33 (0)1 41 29 70 00  
Fax : +33 (0)1 41 29 71 00  
[www.powerlogic.com](http://www.powerlogic.com)  
[www.schneider-electric.com](http://www.schneider-electric.com)

As standards, specifications and designs develop from time to time, always ask for confirmation of the information given in this publication. PowerLogic, ION, ION Enterprise and Modbus are either trademarks or registered trademarks of Schneider Electric.



Printed on recycled paper

PLSED106014EN ART# 821265 01-2010  
© 2010 - Schneider Electric - All rights reserved

Publishing : Schneider Electric  
Production : Schneider Electric PMC  
Printing : Imprimerie du Pont de Claix - made in France